

# CANDID.

design Massimiliano Abati



**Soluzione di forte impatto visivo, e di comoda versatilità, Candid è una struttura in ferro cataforizzato verniciato bianco a polveri che alloggia un esclusivo lavabo in ceramica. E' disponibile con piano in legno, vetro e con cubo contenitore. Gli elementi in legno sono disponibili in tutte le finiture Xilon.**

A conveniently versatile solution with a strong visual impact, Candid is a metal structure with a white powder electro-coated finish, supporting an exclusive ceramic washbasin. It is available with a wooden or glass shelf and with a cube unit. The wooden elements are available in all the Xilon finishes.

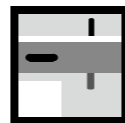



**Mensola in metallo verniciato bianco "Ludos" L20xP15.**

"Ludos" W20xD15 white coated shelf.



**Struttura in metallo con cataforesi, verniciato bianco a polveri, misure L88xP50xH87, completa di lavabo in ceramica piano. Cubo contenitore con ripiano in vetro interno e apertura Push and Pull disponibile a richiesta.**

White powder electro-coated structure, measuring W88xD50xH87, complete with flat ceramic washbasin. Cube unit with glass shelf inside and Push and Pull opening available on request.

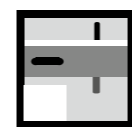

**Contenitore in metallo "Ludos" verniciato bianco L35xP20xH35.**

"Ludos" white coated metal unit, W35xD20xH35.





**Le caratteristiche che rendono la struttura Candid unica e super versatile sono la componibilità, e infatti è fornita in kit composto da cinque elementi e la parte superiore dove è ricavata l'asola porta salvietta può essere montata a dx o a sx capovolgendola.**

The features making the Candid structure unique and extremely versatile are its modularity, and indeed it is supplied in a kit made up of five elements, and the top structure with a slot for use as a towel rail that can be assembled either on the right or the left simply by turning the front panel upside down.

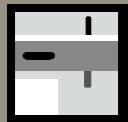



Sovrapponendo i contenitori "Ludos" è possibile combinare l'alta capacità contenitiva al design semplice e funzionale.

By placing "Ludos" containers one on top of the other, ample storage space can be combined with simple and practical design.

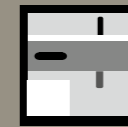

**L'abbinamento tra mensole e contenitori "Ludos" consente di arredare in modo originale.**

The combination of shelves and "Ludos" containers allows to furnish in an original way.



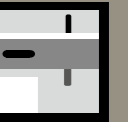



Tavolino rotondo  
 ø60cm, piedini in metallo  
 laccati bianchi. Un pratico  
 appoggio al servizio delle  
 nostre comodità.

ø60cm round table,  
 white lacquered metal legs.  
 A practical and comfortable  
 support.

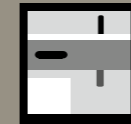

# TECNICO

Technical Specification

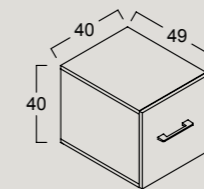
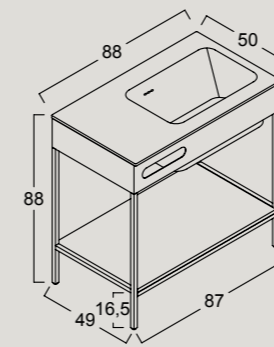

# TECNICO COMPLEMENTI.

Technical Specification/Complements

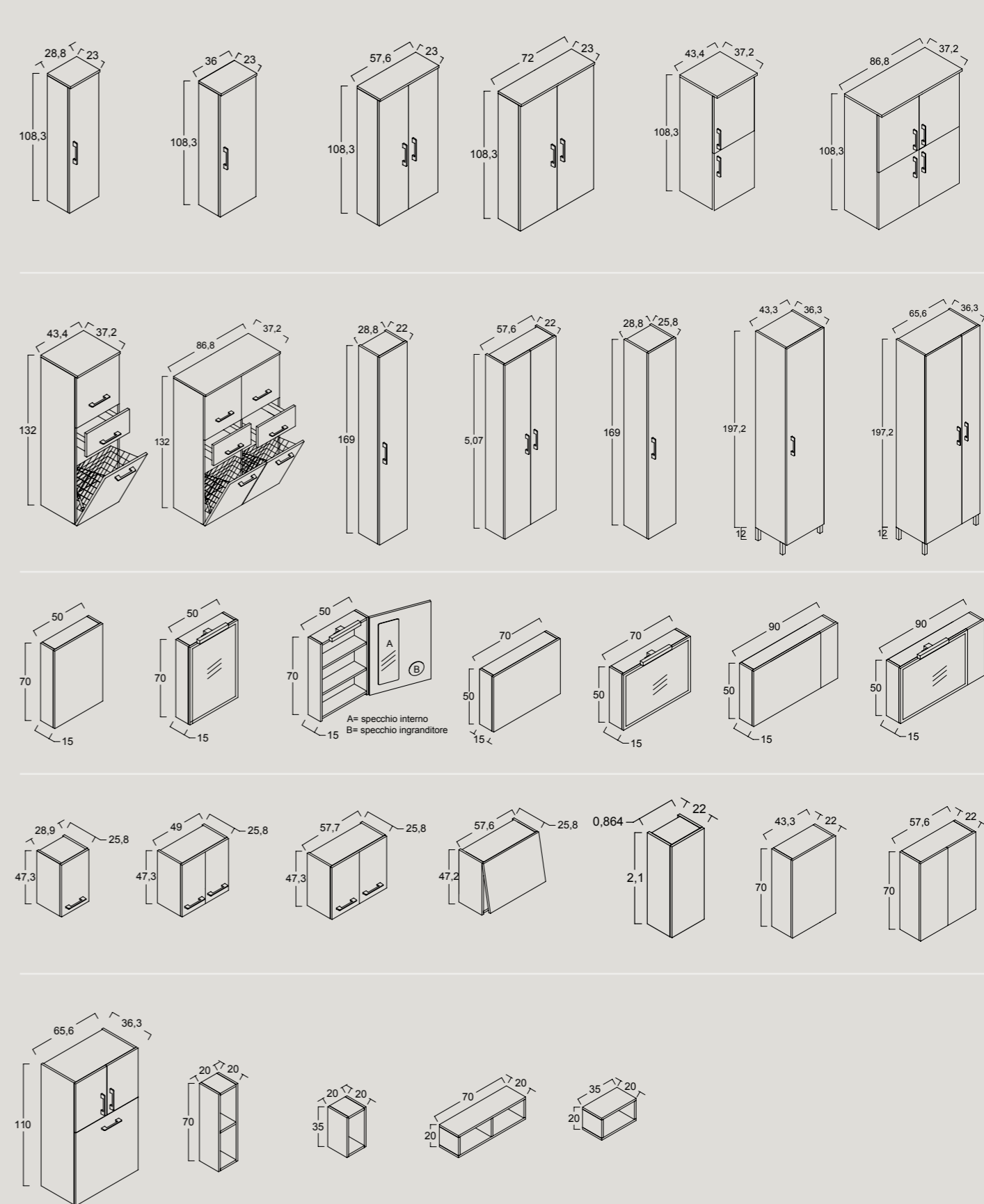
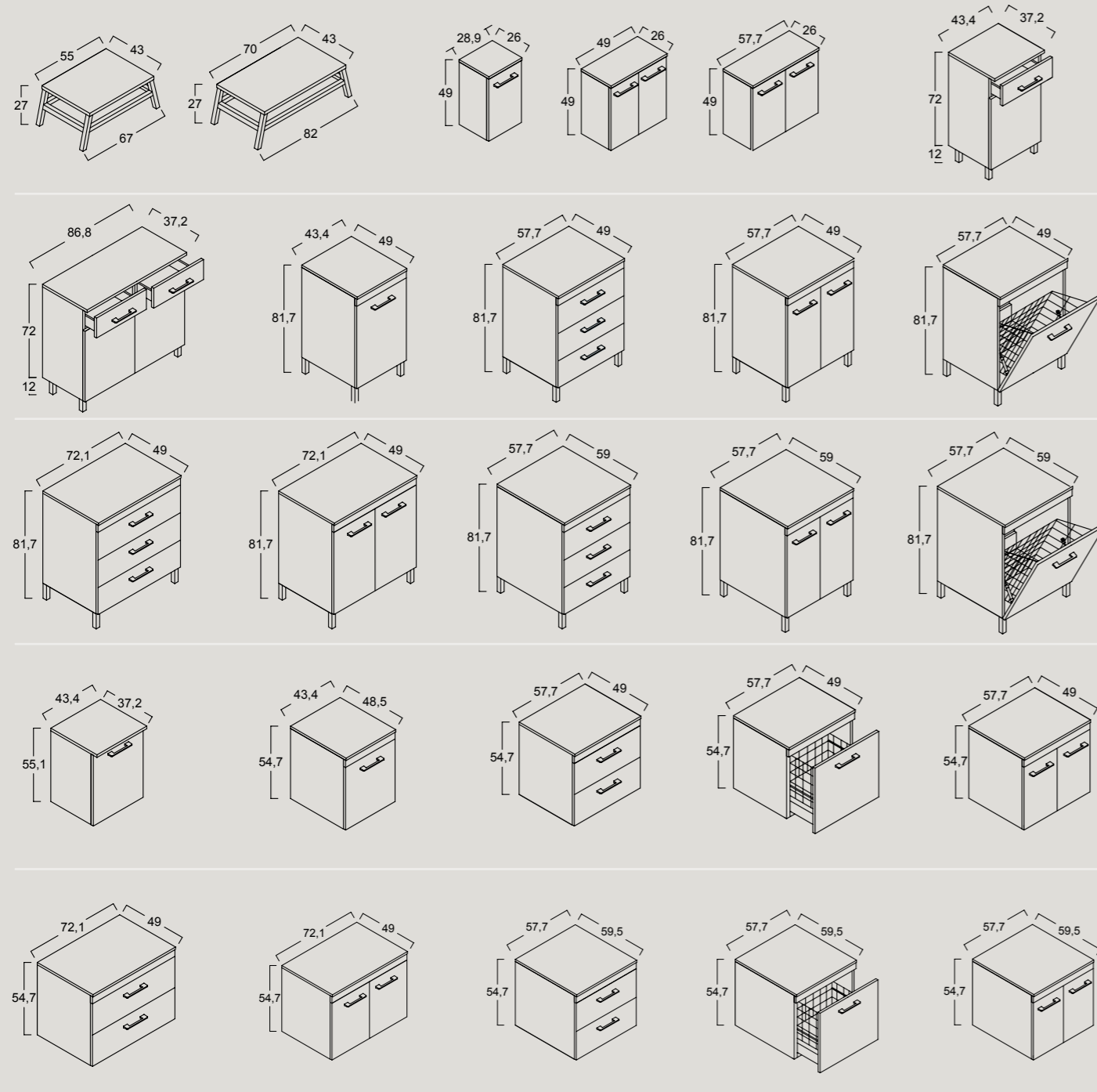



# TECNICO SPECCHI E LUDOS.

Technical Specification/Mirrors and Ludos.

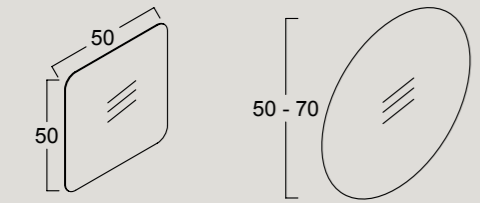
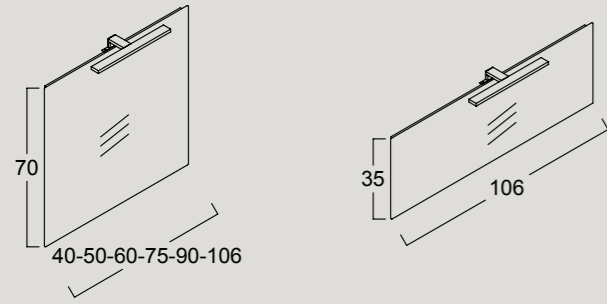

Mensole/Shelves

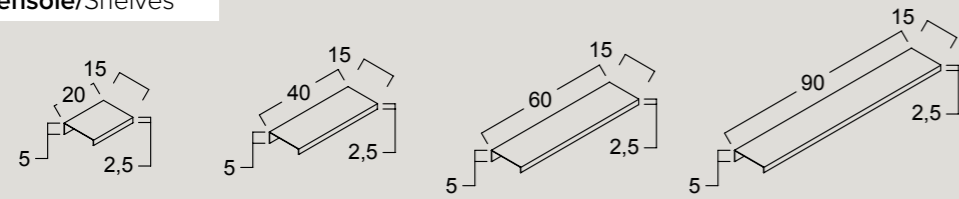

Contenitore a giorno/Open unit

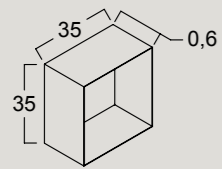

LUDOS.

# TECNICO MANIGLIE E PIEDINI.

Technical Specification/Handles and legs

Belt 160

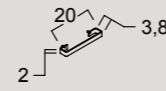

Belt 224

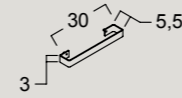

Belt 352



Belt 544

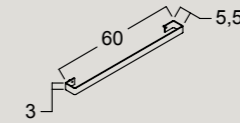

PROFILO 188

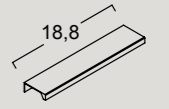

FILO 160

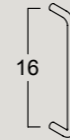

FILO 512

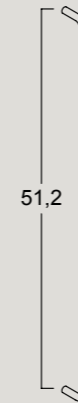

QUADRA 160

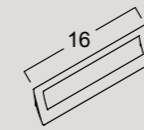

QUADRA 320

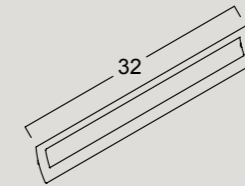

LAMA 160



RETRÒ



MARGERITA

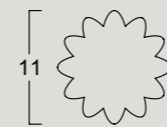

MARGERITA FLEURS

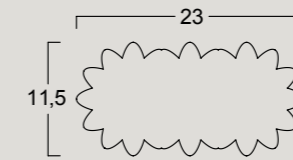

MARGERITA BOUQUET

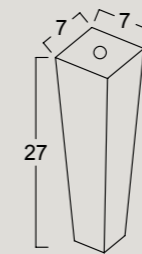
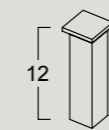
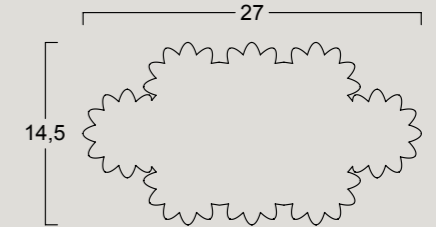

# TECNICO LAMPADE.

Technical Specification/Lamps

# TECNICO ACCESSORI.

Technical Specification/Accessories

ALOGENA

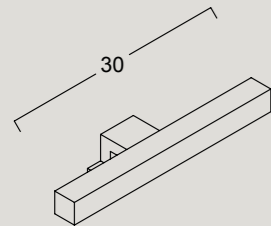

SFERA

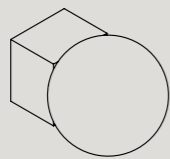

LUNA 30

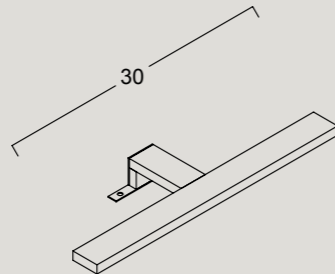

LUNA 50

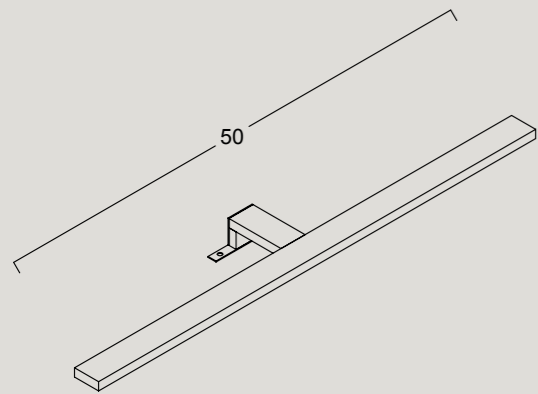

QUAD

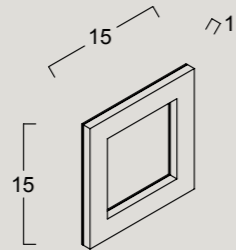

SPLINE



RETTANGOLO

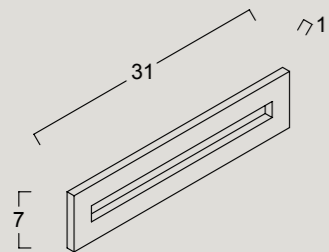

POWER BOX

